

# Accuphase

INTEGRATED STEREO AMPLIFIER

## E-306

- Parallel push-pull output stage delivers quality power: 100 watts/ch into 8 ohms
- Current feedback circuit topology prevents phase shifts
- High-quality phono equalizer for MM and MC cartridges
- Logic-controlled relays for shortest signal paths



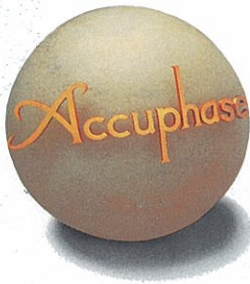

# Current feedback circuit topology assures excellent transient response and superb sonic realism. parallel push-pull output stage delivers a full 100 watts/ch of quality power into 8 ohms. High-performance phono equalizer accommodates MM and MC cartridges. Logic-controlled relays assure reliable source switching.

An integrated amplifier, as the name implies, combines a preamplifier and a power amplifier in a single chassis. The preamplifier handles extremely low-level signals, whereas the power amplifier has to deal with high currents. This means that overall gain is extremely high, and even the slightest interference or crosstalk at the input can have a considerable effect on the sonic result. To preclude this possibility, the E-306 is designed to achieve total electrical and structural separation of the two sections. This integrated amplifier opens up a new chapter in music reproduction, offering sound quality that rivals some of the best separate components.

An important feature of the E-306 is the use of current feedback circuit topology in the power amplifier. This principle developed by Accuphase virtually eliminates phase shifts in the upper frequency range and assures uniform frequency response which does not change with gain. In other words, it combines total operation stability with excellent frequency response. Thanks to this principle, phase compensation can be kept at a minimum, and high amounts of negative feedback with their associated disadvantages are no longer required. This assures excellent transient response, with superb sonic transparency and detail. Music reproduced by the E-306 sounds uncannily real.

The preamplifier section incorporates a high-quality discrete-type line amplifier and a phono equalizer for reproduction of analog discs, using MM or MC cartridges. All parts and circuit components of the E-306 have been strictly selected for sonic purity. A versatile complement of nine inputs including two balanced inputs can accommodate a wide variety of program sources. All switching is performed by logic-controlled hermetically sealed relays with gold contacts. A supplied remote commander lets you adjust the volume and select input sources from anywhere in the listening room.

In the interest of assuring top-quality sound, the number of features has been limited to include only truly essential and useful functions. The simple, uncluttered design in the Accuphase tradition makes the E-306 a joy not only for the ears but for the eyes as well.

## Parallel push-pull output stage delivers quality power: 140 watts/channel into 4 ohms, 120 watts/channel into 6 ohms or 100 watts/channel into 8 ohms

Figure 1 shows a circuit diagram of the power amplification stage. The power transistors are designed for audio applications and have been selected for optimum frequency response, forward-current transfer ratio linearity, and switching performance characteristics. By mounting the devices to a large heat sink and connecting them in parallel, the E-306 achieves ample power output capabilities, providing a 140 watts into 4 ohms, 120 watts into 6 ohms, or 100 watts into 8 ohms per channel.

## Current feedback circuit topology prevents phase shifts

When the gain of an amplifying circuit increases, frequency response, i.e. the bandwidth that can be handled by the amplifier, becomes more narrow. To counter this effect, a commonly employed technique called negative feedback (NFB) routes part of the output signal back to the input. If phase shift is disregarded, a circuit designed to have high open-loop-gain can apply a high amount of NFB, resulting in the wide frequency response of a closed-loop circuit, as shown in Figure 2.

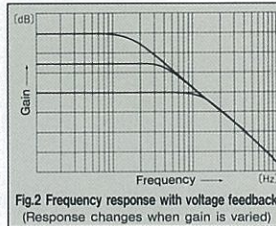

Fig.2 Frequency response with voltage feedback (Response changes when gain is varied)

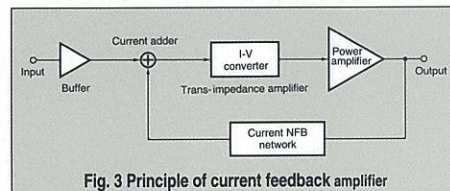

Fig. 3 Principle of current feedback amplifier

Conventional amplifiers employ voltage NFB, whereby the output voltage is used for the feedback loop. In the E-306 however, the signal cur-

rent rather than the voltage is used for feedback. Figure 3 shows the operating principle of this circuit. At the sensing point of the feedback loop, the impedance is kept low and current detection is performed. An impedance-converting amplifier then converts the current into a voltage to be used as the feedback signal.

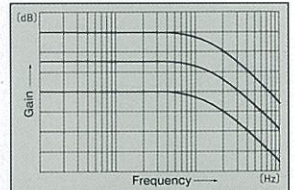

Fig.4 Frequency response with current feedback (Response does not change when gain is varied)

Since the impedance at the current feedback point (current adder in Fig. 3) is very low, there is almost no phase shift. Phase compensation therefore can be kept to a minimum, resulting in excellent transient response and superb sonic transparency. Figure 4 shows frequency response for different gain settings of the current feedback amplifier. The graphs demonstrate that response remains uniform over a wide range.

## Robust power supply with large power transformer and high filtering capacity

The power supply plays a vital role as the source of energy for the power amplifier section. The E-306 spares no efforts in this regard, featuring a large 500 VA power transformer and two large electrolytic capacitors rated for 22,000  $\mu\text{F}$  each. This assures ample reserves also for reproduction of demanding bass passages.



## Discrete-type line amplifier for superior sonic purity

The line amplifier whose circuit diagram is shown in Figure 5 is entirely built from discrete parts, to assure optimum performance. Circuit design is based on the differential pure complementary push-

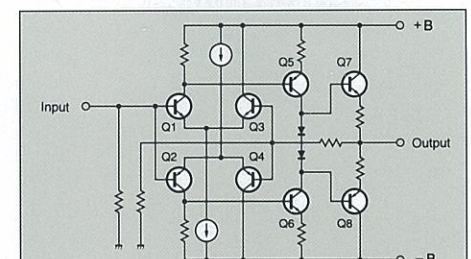

Fig.5 Circuit Diagram of the Line Amplifier (one channel)

pull principle developed by Accuphase, while the output stage is a single-ended push-pull emitter follower. This comparatively simple circuit topology requires only minimal amounts of phase compensation in each stage, which enhances signal purity and results in effortless, utterly natural sound.

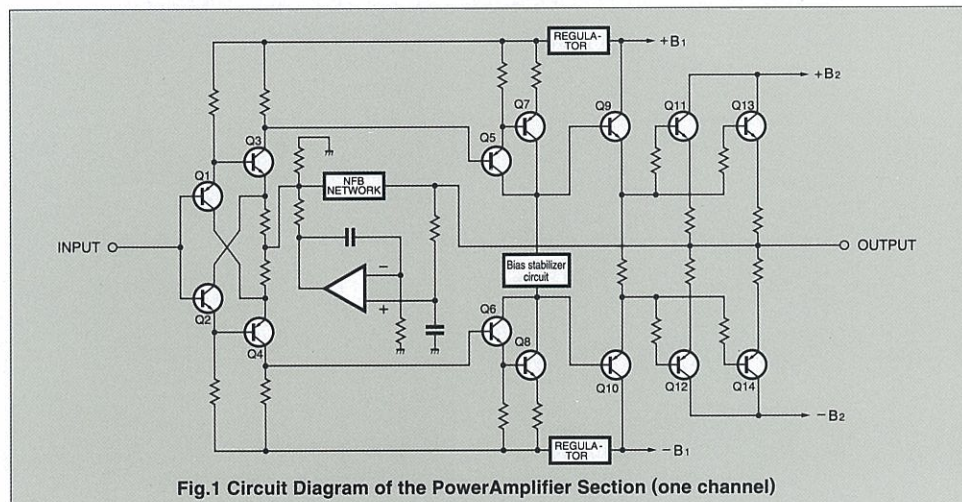

Fig.1 Circuit Diagram of the Power Amplifier Section (one channel)



**High-quality phono equalizer stage accommodates MM and MC cartridges**

The E-306 incorporates a high-performance phono stage (Fig. 6) designed to enable top-notch reproduction of your valuable analog records. Separate input circuits are provided for moving-coil (MC) and moving-magnet (MM) cartridges, to fully bring out the advantages of each cartridge type. Since MM cartridges have high output voltage as well as high output impedance, the FET input stage is designed to maintain high input impedance over the entire frequency range. On the other hand, the MC section has to deal with very low-level signals at low impedances. Therefore, two low-noise de-

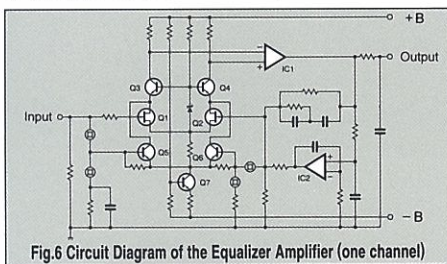

Fig.6 Circuit Diagram of the Equalizer Amplifier (one channel)

vices are arranged in a differential configuration with a low-impedance NFB loop, to assure optimum signal-to-noise ratio and keep residual noise at a minimum.

**Highly reliable logic-controlled relays**

Long signal paths for functions such as input switch-



ing and tape monitoring tend to degrade high-frequency response and impair imaging. In the E-306, all switching is performed by logic-controlled relays which are arranged so as to permit the shortest possible signal paths. The hermetically sealed relays are high-quality types developed specifically for demanding communication applications. The contacts are twin crossbar types plated with gold for minimum contact resistance and outstanding long-term reliability.

**Versatile input configuration including balanced connectors**

In order to accommodate the ever increasing variety of program sources, the E-306 offers eight inputs controlled by the input selector plus another input for a tape recorder. Two of these inputs are designed for balanced connections. The principle of balanced signal transmission is shown

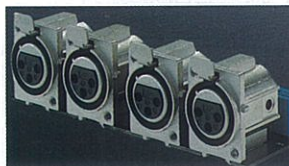

Balanced input with XLR connectors

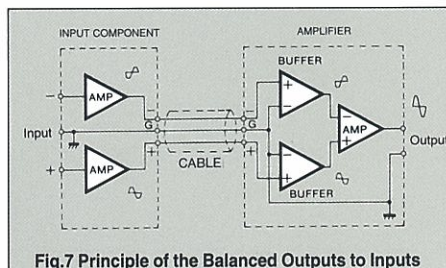

Fig.7 Principle of the Balanced Outputs to Inputs

in Figure 7. At the source component, the signal is converted into a positive and negative signal with identical voltage potential but phase-inverted by 180 degrees. The receiving equipment precisely

combines the two signals. Since any noise which was picked up by the connecting cable etc. has the same phase in both lines, it is canceled by the mixing process, ensuring noise-free signal transmission with optimum sonic purity.

**Remote commander allows source switching and volume adjustment**

Listening level adjustment is performed by a small motor which drives the volume control via a clutch, for smooth, reliable action. The input selector controls the relays in the E-306, offering remote control convenience without any sacrifices in sound quality.

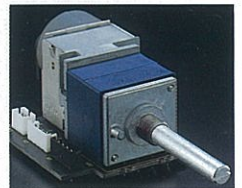

**Independent use of preamplifier and power amplifier possible**

Separate outputs and inputs controlled by a selector switch allow use of the preamplifier section and the power amplifier section as separate components.

**Large, direct-reading peak power meters**

The large analog power meters have a peak hold function which lets you easily monitor the output level of the rapidly fluctuating music signal. Thanks to logarithmic compression, the meters cover a wide dynamic range.

**Heavy-duty speaker terminals accommodate also banana plugs**

The oversize speaker terminals accept even very heavy-gauge speaker cable, and it is also possible to insert banana plugs.





Amplifier circuitry and parallel push-pull output devices mounted to large heat sink.

■ FRONT PANEL

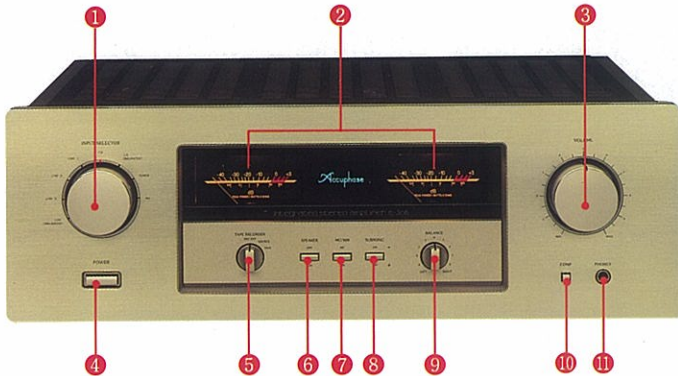

■ REAR PANEL

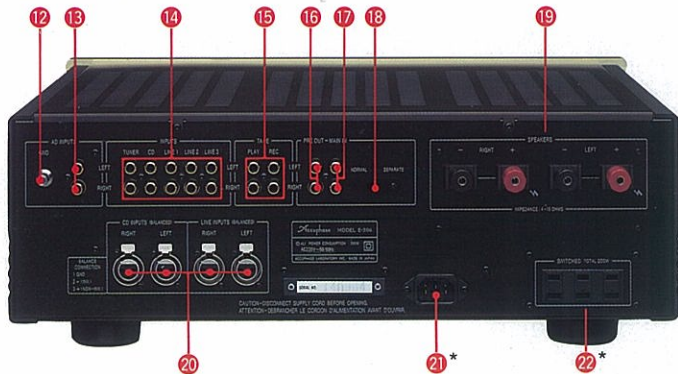

- ① Input selector: LINE(BALANCED), LINE-3, LINE-2, LINE-1, CD, CD (BALANCED), TUNER, AD
- ② Left and right channel output meters (dB div., wattage direct reading)
- ③ Volume control
- ④ Power switch
- ⑤ Record output/tape monitor switch: REC OFF, SOURCE, TAPE
- ⑥ Speaker ON/OFF switch
- ⑦ MC/MM selector
- ⑧ Subsonic filter
- ⑨ Volume balance control
- ⑩ Compensator switch
- ⑪ Headphone jack
- ⑫ Ground terminal
- ⑬ AD (analog disc) input jack
- ⑭ Input jacks: CD, TUNER, LINE-1,2,3
- ⑮ Tape input / recording output jacks
- ⑯ Preamp output jacks
- ⑰ Power amplifier input jacks
- ⑱ Preamp/power amplifier separation switch
- ⑲ Left and right channel output terminals
- ⑳ CD / LINE balanced input connectors: ① Ground, ② Inverted (-), ③ Non-inverted (+)
- ㉑ AC power connector\* (for supplied power cord)
- ㉒ Switched AC outlets\*

**Remarks**  
 \*The shape of the AC inlet, plug of the supplied power cord, and AC outlet depend on the voltage rating and destination country.  
 \*These switched AC outlets may not be supplied depending on the safety standards or regulations applicable in the particular country or where the unit is desired.

※ Specifications and design subject to change without notice for improvements.

■ Remote commander RC-14  
 Allows volume adjustment and input source switching.



■ Power amplifier assembly (one channel)

- ① Parallel NPN output transistors
- ② Current feedback input buffer
- ③ DC servo OP amplifier
- ④ Parallel PNP output transistors

■ Preamp assembly

Contains the discrete line amplifier, voltage regulator, equalizer with dedicated MC/MM input circuits, and other circuitry.

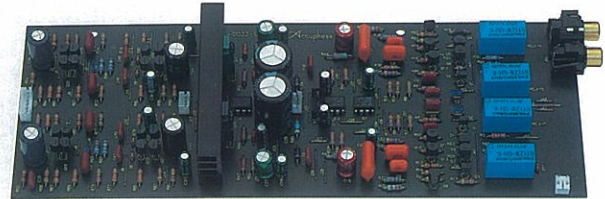

GUARANTEED SPECIFICATIONS

Guaranteed specifications are measured according to EIA standard RS-490. AD denotes Analog Disc input.

Performance Guaranty

All Accuphase product specifications are guaranteed as stated.

- Continuous Average Output Power (Both channels driven, 20 - 20,000 Hz) 140 watts per channel into 4 ohms  
120 watts per channel into 6 ohms  
100 watts per channel into 8 ohms
- Total Harmonic Distortion 0.04%, with 4 to 16 ohms load (both channels driven)
- Intermodulation Distortion 0.01%
- Frequency Response MAIN/HIGH LEVEL INPUT : 20 - 20,000 Hz +0, -0.2 dB  
LOW LEVEL INPUT : 20 - 20,000 Hz +0.2, -0.5 dB  
120 (with 8-ohm load, 50 Hz)
- Damping Factor MM : 250 mV rms, 1 kHz, THD 0.005% (REC OUT)  
MC : 7.0 mV rms, 1 kHz, THD 0.005% (REC OUT)
- Maximum AD Input Level

● Input Sensitivity, Input Impedance

Input	Sensitivity		Input impedance
	For rated output	For 1 W output (EIA)	
AD INPUT(MC)	0.11mV	0.01mV	100Ω
AD INPUT(MM)	3.9mV	0.39mV	47kΩ
HIGH LEVEL INPUT	113mV	11.3mV	20kΩ
BALANCED INPUT	113mV	11.3mV	40kΩ
MAIN INPUT	1.11V	112mV	20kΩ

● Rated Output Level and Impedance

PRE OUTPUT : 1.11 V, 50 ohms  
 TAPE REC OUTPUT : 110mV, 200 ohms (from AD input)

● Gain

MAIN INPUT → OUTPUT : 28 dB  
 HIGH LEVEL INPUT → PRE OUTPUT : 20 dB  
 AD INPUT (MM) → TAPE REC OUTPUT : 29 dB  
 AD INPUT (MC) → TAPE REC OUTPUT : 60 dB  
 +6 dB (200 Hz) (Volume control setting -30 dB)

● Loudness Compensation

● Signal-to-Noise Ratio

Input	Input shorted, IHF-A weighting S/N ratio at rated output	EIA S/N
MAIN INPUT	124dB	102dB
HIGH LEVEL INPUT	110dB	83dB
BALANCED INPUT	90dB	82dB
AD INPUT(MM)	85dB	80dB
AD INPUT(MC)	70dB	78dB

● Subsonic Filter

Cutoff frequency 25 Hz, -12 dB/octave

● Power Level Meters

Logarithmic compression, peak reading meters dB and direct watt-reading (8-ohm load) scale 4 - 16 ohms

● Load Impedance

Suitable impedance: 4 - 100 ohms

● Stereo Headphones

100 V, 120 V, 220 V, 230 V, 240 V (Voltage as indicated on rear panel) AC, 50/60 Hz

● Power Requirements

50 watts idle  
 290 watts in accordance with IEC-65

● Power Consumption

Width 475 mm (18-11/16")  
 Height 170 mm (6-11/16")  
 Depth 418 mm (16-7/16")

● Weight

20.2 kg (44.4 lbs) net  
 25.0 kg (55 lbs) in shipping carton

● Supplied Remote Commander RC-14

Remote control principle: infrared pulse  
 Power supply: 3 V DC (IEC R6 batteries x 2)  
 Dimensions: 45 mm width (1-3/4")  
 136 mm height (5-3/8")  
 18 mm depth (11/16")  
 Weight: 85 g (including batteries)



ACCUPHASE LABORATORY INC.

851-0129-00(AD1) PRINTED IN JAPAN