

Accuphase

C-260

STEREO CONTROL CENTER

- High Quality, Ideally Balanced Transmission Line Amplifier
- Class A Push-Pull Amplifier with DC Servo System for All Stages
- Completely Separate Twin Mono Construction through Independent Power Supply
- A Newly Developed 4-Gang Audio Volume Control





The unparalleled performance of the new Accuphase C-260 Stereo Control Center sets a new standard for the times. Dependability is built in with features such as Class-A push-pull circuits with exclusive power supplies that control line amplifiers for a balanced transmission system. And the complete twin mono construction incorporates independent power transformers. The versatility of the innovative C-260 makes it a unique and powerful stereo control center.

A preamplifier or a "Control Center", as we call it here, is positioned between the power amplifier and such musical sources as a CD player, analog turntable, tuner, DAT recorder, etc., conveniently controlling the signal traffic and adjusting the signal volume to any desired level. This is the main function required of a preamplifier. However, it must also provide absolutely uncolored sound reproduction whereby the listener will not even notice its existence.

Employed by the very first model of the C-200 series preamplifiers is a pure complementary push-pull amplifier circuit, a truly ideal amplification circuit topology. As the series advanced, such additional circuit features as a direct coupled and cascode bootstrap circuit were added. Further, a balanced signal transmission circuit was very quickly employed for both the input and output stages, in order to further improve the audio quality.

In the C-260, the circuit perfection has been furthered by successfully developing an output circuit consisting of a single amplifier and no transformer. This is an ideally balanced signal transmission circuit, which does not require a common ground.

Accuphase's original logic relay control circuit has been employed to control complex audio signal traffic. The relays used are in a sealed casing, thus not exposing the electric contacts to air, which guarantees many years of perfect operation and high quality sound reproduction.

Special attention has been paid to the audio volume control, which normally tends to be a big

source of sound deterioration. The resistor element of the control is polished very precisely to reach a mirror-like smoothness. This newly employed volume control rotates the resistor elements unlike the conventional volume control, in which the collectors rotate. Thus, it successfully reduces the number of metal joints, which have been a source of sound deterioration, resulting in a remarkable improvement of the distortion characteristics.

The C-260 provides a number of functions worthy to its designation as a "Control Center". All functions, other than those most commonly used, are logically organized under the hinged front sub-panel. This assures the utmost ease of operation while maintaining a simple overall appearance.

We are confident that the C-260 incorporates all the technical know-how that Accuphase has accumulated since its foundation. It combines superb performance characteristics, excellent operational functions and beautiful design, all of which have been refined to their utmost, bringing you a step higher in the fascination of sound reproduction.

operated in the balanced signal transmission connection as shown in Fig. (a). Even when unbalanced external equipment is connected to the inputs, outputs or both, the new balanced line amplifier circuit of the C-260 simply grounds the negative signals, while maintaining its original circuit configuration functioning fully as an ideal balanced transmission system. In other words, the circuit, through which signals pass, remains the same whether or not it is used with balanced or unbalanced connections, thus successfully eliminating any changes in the signal path that may deteriorate sound quality.

This ideally balanced circuit based on the signal transmission theory, guarantees remarkably improved S/N characteristics, thanks to the excellent noise reduction when employed in a balanced connection.

Excellent Basic Characteristics for Line Input Amplifier

Fig. 3 shows a circuit diagram for the balanced input amplifier. It is based on Accuphase's original differential complementary push-pull input amplifier and cascode push-pull amplifier circuits. The input stage, in which a high-gm type FET is employed, consists of a constant current load type cascode circuit. The C-260 operates as a balanced input amplifier, when the input signals are connected to the positive (+) and negative (-) terminals. It operates as an unbalanced amplifier, when the input signals are connected to the common ground and positive terminals. Naturally, these am-

High Quality, Ideally Balanced Transmission Line Amplifier

Fig. 1 is a circuit block diagram of the C-260. The simplified functional explanation of the balanced line amplifier stage is shown in Fig. 2. As shown, AMP2 and AMP3 complement each other's operation. As a result, no common ground (G) exists in the circuit, thus forming an ideal amplifier circuit, when

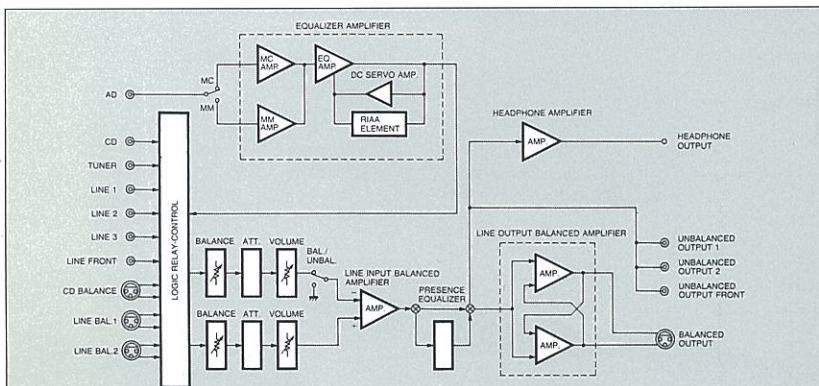

Fig. 1 Circuit block diagram of C-260 (one channel)

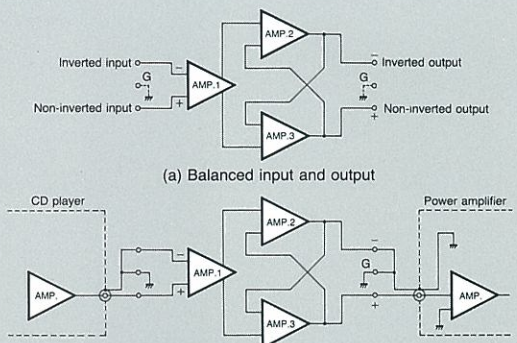

Fig. 2 Balanced line amplifier stage

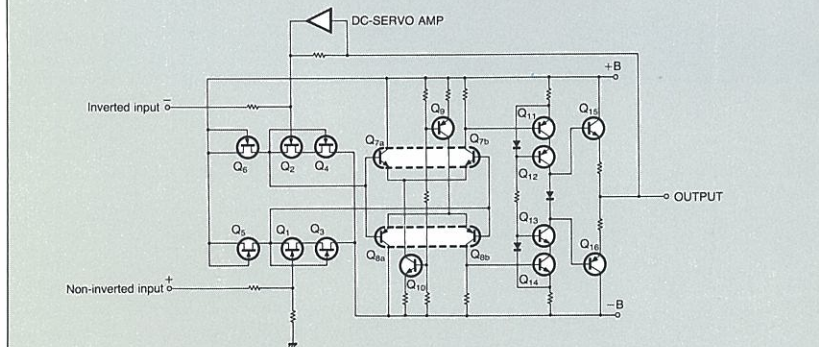

Fig. 3 Circuit diagram for the balanced input amplifier

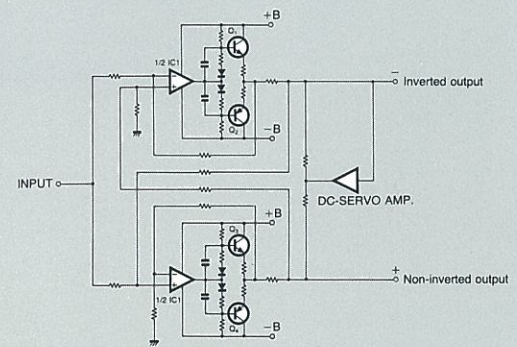

Fig. 4 Circuit diagram for the balanced output amplifier



plifier stages are constructed in a direct coupled configuration with a DC servo circuit. Shown in Fig. 4 is the balanced output circuit diagram. It consists both of a differential operational amplifier circuit and a push-pull drive output circuit, thus achieving excellent low distortion and low impedance characteristics.

A Newly Developed 4-Gang Audio Volume Control

One of the most important functions of the "Control Center" is to control the audio volume without any sound deterioration. The volume control employed in the C-260 has resistor components, whose surface has been polished to a mirror-like smoothness, thus resulting in a remarkable low distortion characteristic and greatly reduced wear and tear. Moreover, the volume control has no sound deteriorating additives, such as grease applied between the collectors and resistors. Conventional volume controls have rotating collectors and fixed resistors connected to external terminals with leads going through rivet holes. The volume control employed in the C-260 instead has rotating resistors and fixed

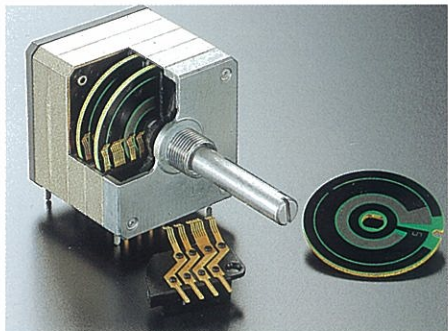

collectors that are connected directly to the external terminals. This construction has successfully reduced the number of metal joints from 5 to 3, thus greatly contributing to the improvement in sound quality. This volume control is a precision 4-ganged type, controlling the positive and negative signals of the left and right channels simultaneously. It is ganged so precisely to ensure a smooth rise in sound levels of both channels.

Completely Separate Twin Mono Construction for Amplifier and Power Supply Stages

Each of the equalizer amplifier, line amplifier and presence control amplifier has its own independent power supply. In addition, each channel is equipped with an exclusive power transformer in order to perfect a complete electrical separation between the two channels. Moreover, each of the two channels has its own unit amplifier, which is completely separated in construction in order to eliminate inter-channel interference.

Newly Developed High Quality Exclusive Headphone Amplifier

The primary purpose of a preamplifier is to control the signals entering the power amplifier, but headphones may also be connected for monitoring applications or during the late evening hours, when one can not listen to music at high levels. The C-260's DC servo, direct coupling headphone amplifier can ideally drive headphones with a wide range of impedances.

Presence Control Offers a Versatile 4-Point, 6-Frequency Control

The C-260 is equipped with a control that permits subtle adjustments of reproduced sound from a wide variety of musical program sources. Graphic equalizers are originally intended for this purpose, but their numerous controls often make them difficult to use.

The newly developed "Presence Control" of the C-260 is specially designed to achieve the most pleasing aural impression during music reproduction. Adjustments are made at preset turnover points with four controls governing six frequency ranges.

For instance, the center points of the mid-fre-

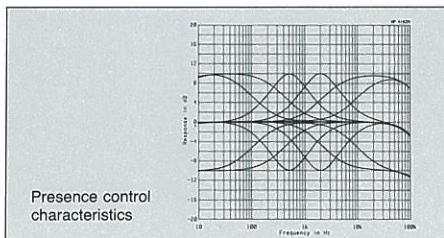

quency range are set at 500Hz and 2kHz. The 500Hz control can effect, for example, the timbre of rhythm instruments and the 2kHz control can be used to emphasize vocals or reduce traces of stringency.

Extensive listening tests were carried out to determine the Q factor for these controls, which expresses the steepness of the tone control curve. A value of $Q=0.707$ was finally chosen, as it provides the most natural sounding results with a wide variety of program sources.

The overall tonal energy balance can be adjusted with the Bass and Treble controls, which possess two switchable turnover frequencies.

The circuit configuration of the Presence Control is shown in Fig. 5. It consists of a combination of summing filters, which feature the minimum of sound deterioration. All parts were strictly selected on the basis of their sonic performance, so that sound quality is not degraded when the control is in use. It can be, however, defeated from the circuit, when so desired.

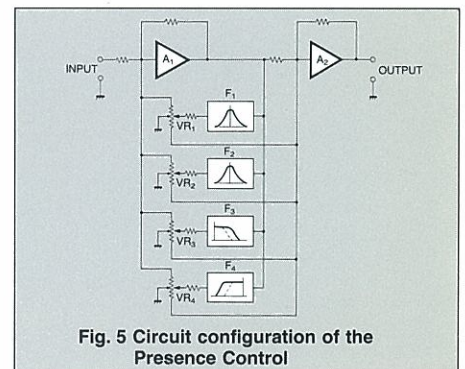
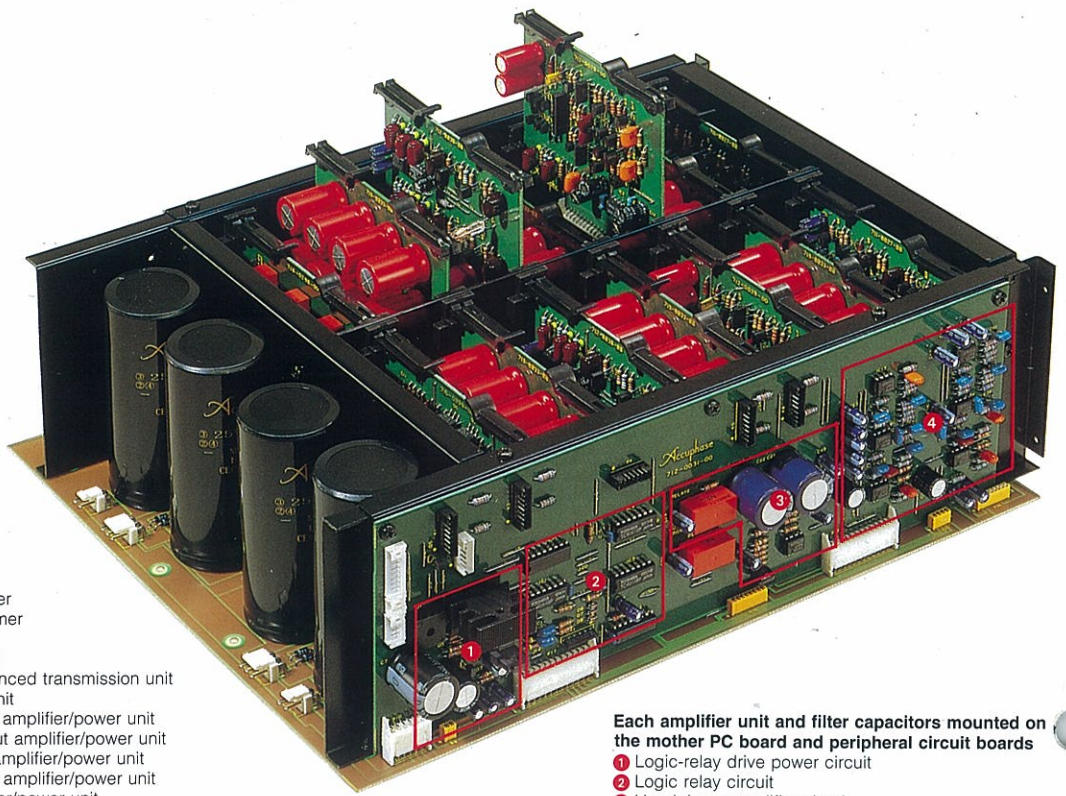
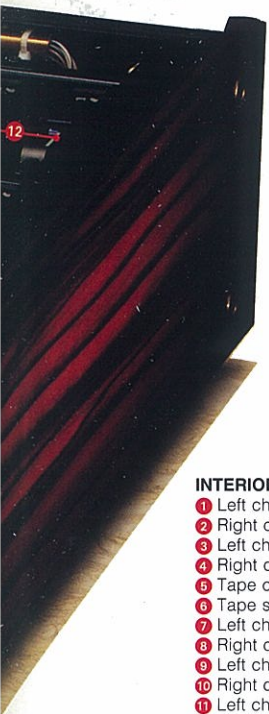

Fig. 5 Circuit configuration of the Presence Control

Phono Equalizer Amplifier Matches All Types of MM and MC Cartridges

In this CD age, ironically, some records are becoming more and more valuable. The phono equalizer amplifier has been newly developed with the aim to perfectly reproduce the excellent characteristics of analog recordings. Fig. 6 is the circuit diagram of the C-260's phono equalizer.

As shown in the block diagram of Fig. 1, the C-



INTERIOR LAYOUT

- 1 Left channel power transformer
- 2 Right channel power transformer
- 3 Left channel filter capacitors
- 4 Right channel filter capacitors
- 5 Tape output balanced/unbalanced transmission unit
- 6 Tape signal switching relay unit
- 7 Left channel balanced output amplifier/power unit
- 8 Right channel balanced output amplifier/power unit
- 9 Left channel balanced input amplifier/power unit
- 10 Right channel balanced input amplifier/power unit
- 11 Left channel equalizer amplifier/power unit
- 12 Right channel equalizer amplifier/power unit

Each amplifier unit and filter capacitors mounted on the mother PC board and peripheral circuit boards

- 1 Logic-relay drive power circuit
- 2 Logic relay circuit
- 3 Headphone amplifier circuit
- 4 Presence control circuit

C-260 is equipped with an exclusive input circuit each for MM and MC cartridges to extract an excellent performance from a wide range of MM and MC cartridges. The input circuit for MM cartridges consists of high S/N FET's (Q₁, Q₂, Q₃, and Q₄) to match their high output impedance. The MC circuit is composed in a differential input circuit configuration by using extremely low noise devices (Q₅ and Q₆), which have made it possible to lower the impedance of the NFB loop and to achieve low noise sound reproduction.

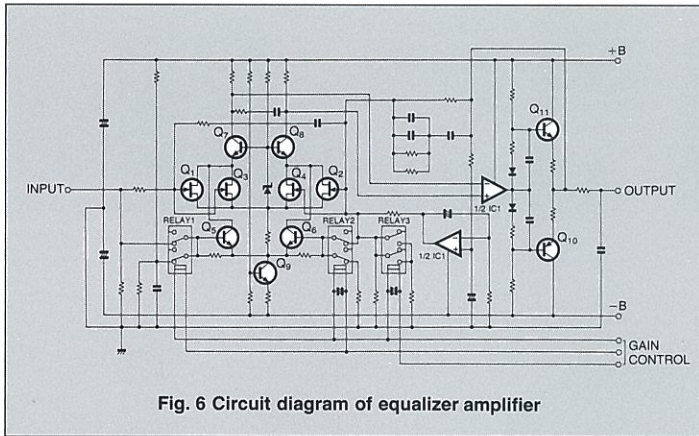
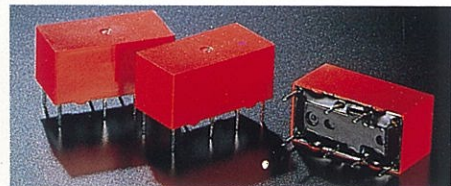

Fig. 6 Circuit diagram of equalizer amplifier

The gain of the phono equalizer can be switched depending upon the output of the phono cartridge used; 60dB for MC and either 30dB or 36dB for MM.

Highly Reliable Logic-Relays Permit Straight and Short Signal Paths.

One of the primary functions of the preamplifier is to control signal traffic by switching input sources or selecting various functional modes. The audio signals are so delicate that they tend to degrade sound quality, if not carefully handled. Since the metal joints in relay switches can be worn out by sulphurized gas from cigarette smoke, the C-260 employs, for all the points that switch audio signals, a closed type relay filled with nitrogen gas. The contacts of the relay are a gold plated twin cross-bar type, which has been specially developed for audio and industrial communication equipment use. Its



highly reliable performance guarantees a long time of perfect operation and at the same time successfully eliminates sound deterioration.

Balanced to Unbalanced Transmission Conversion Amplifier Exclusively for Tape Output.

For the tape recording output, the C-260 provides an exclusive signal transmission converting amplifier that converts balanced input to unbalanced output signals. Therefore, the balanced inputs can be handled in the same manner as the unbalanced input sources. The C-260 provides two tape recorder input terminals, to enable dubbing between two tape recorders, thus presenting powerful recording possibilities with versatile program sources.

Unsurpassed Input/Output Versatility For Multiple Program Sources

Following the C-200 series preamplifiers, the C-260 was designed to accommodate a wide variety of input and output combinations, thus meeting the prerequisites of a "Control Center".

Provided are three pairs of balanced inputs, seven pairs of unbalanced inputs including analog disc (AD), two pairs each of tape inputs and outputs, one balanced and three unbalanced outputs. Of these, one pair each of inputs and outputs is located under the hinged sub-panel making it convenient for the connection of peripheral devices.

Other Features

The C-260 incorporates a loudness compensator switch, which can be used to emphasize the low frequency energy at low audio volume. Its characteristics are automatically changed in accordance with the position of the volume control; i.e. +6dB with the volume control position at -30dB or +4dB with the volume control at -20dB respectively at the 100Hz position.

An attenuator provided can instantaneously attenuate the volume down to -20dB, thus making it convenient to respond to a telephone call or to search for a certain position of a musical selection without touching the main volume control.

Also incorporated is a sub-sonic filter with filtering characteristics of -12dB/Oct. at 17Hz. It is indispensable when reproducing analog records in order to cut out ultra low frequency noise, which may be caused by a warped analog records.

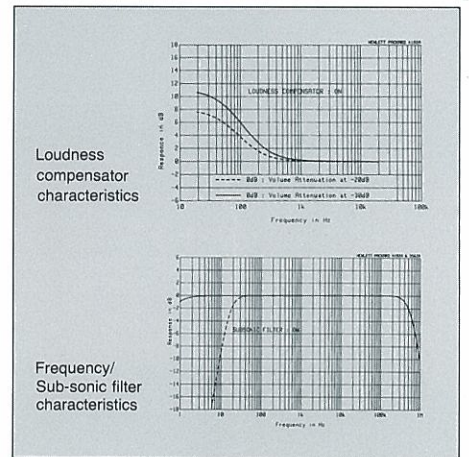

Luxurious Persimmon Wood Sidepanels

The upper plate of the C-260 is made of thick aluminum with a satin finish, while the front panel is made of Accuphase's traditional thick aluminum finished in brushed champagne gold. The entire unit is flanked by sidepanels made of exquisite natural persimmon wood to harmoniously blend in with the atmosphere of your listening room.

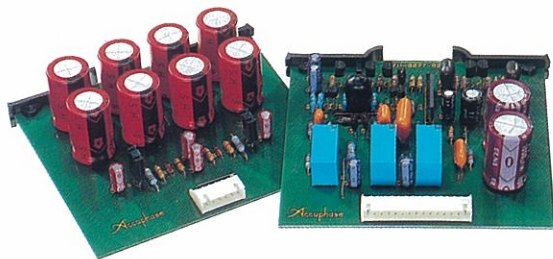

The phono equalizer amplifier has a dedicated power supply unit and features an exclusive input circuit compatible with all cartridges, including MM and MC.

The logic relay control circuit board incorporates highly reliable sealed relays charged with nitrogen.

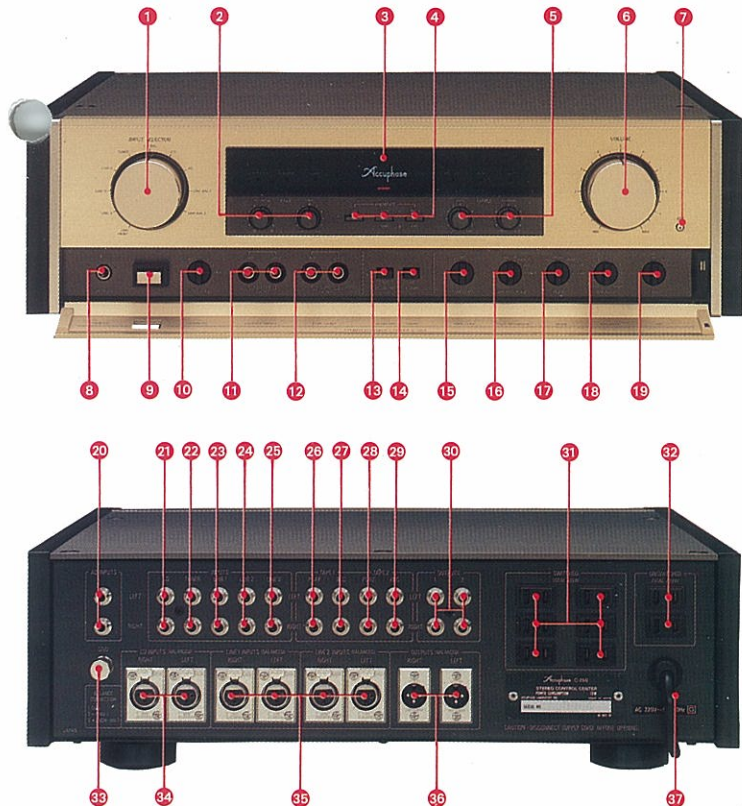
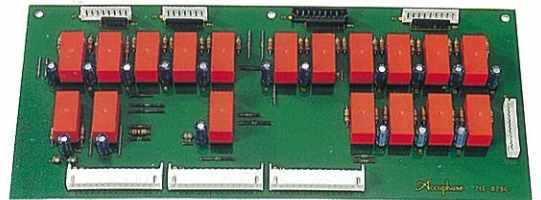

FRONT/REAR PANELS

- 1 Input selector
LINE FRONT, LINE-3, LINE-2, LINE-1, TUNER, CD-BAL, CD, AD, LINE-BAL 1, LINE-BAL 2
- 2 Presence control (BASS)
40/100Hz, 500Hz
- 3 Function display LEDs
MUTING: ON/OFF, OUTPUT: ON/OFF, SUBSONIC: ON/OFF, COMP: ON/OFF, REC OUT: ON/OFF, STEREO/MONO, MC: ON/OFF
- 4 Presence control ON/OFF switch/frequency selection switch
ON/OFF, 40Hz/100Hz, 20kHz/8kHz
- 5 Presence controller (TREBLE)
2kHz, 8/20kHz
- 6 Volume control
- 7 Attenuator (-20dB)
- 8 Headphone jack
- 9 Power switch
- 10 Output selector
OFF, ALL, 1, 2, FRONT
- 11 Front output jack
- 12 Front LINE input jack
- 13 Subsonic filter switch (17Hz: -12dB/Oct.)
- 14 Loudness compensator switch
- 15 Tape copy switch
1→2, OFF, 2→1
- 16 Recording output ON/OFF switch/
Tape monitor switch
REC OFF, SOURCE, TAPE-1, TAPE-2
- 17 Mode selector switch
REV., STEREO, MONO, R→L&R, L→L&R
- 18 Balance adjuster

- 19 Equalizer gain switch
MC, MM1 (30dB), MM2 (36dB)
- 20 Analog player input jack
- 21 Unbalanced CD input jack
- 22 Tuner input jack
- 23 LINE-1 input jack
- 24 LINE-2 input jack
- 25 LINE-3 input jack
- 26 TAPE-1 input jack
- 27 TAPE-1 recording output jack
- 28 TAPE-2 input jack
- 29 TAPE-2 recording output jack
- 30 Output jacks (unbalanced: 2)
- 31 AC outlet (switched)*
- 32 AC outlet (unswitched)*
- 33 GND terminal
- 34 Balanced CD input connectors
XLR-3-31 equivalent: ① Ground, ② Inverted (-), ③ Non-inverted (+)
(Suitable connector: XLR-3-12C equivalent)
- 35 Balanced line input connectors (2)
- 36 Balanced output connectors
XLR-3-32 equivalent: ① Ground, ② Inverted (-), ③ Non-inverted (+)
(Suitable connector: XLR-3-11C equivalent)
- 37 AC power cord

Remarks
*These switched and unswitched AC outlets may not be supplied depending on the safety standards or regulations applicable in the particular country to where the unit is destined.

From the howling winds of time and change emerges the Accuphase tradition, honed, polished and shining. Meet the new tradition

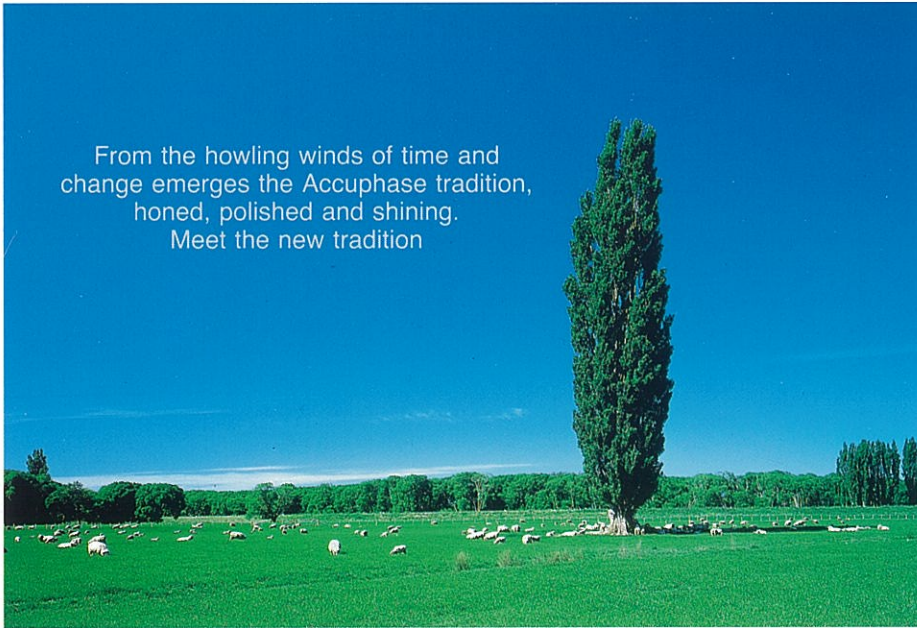

enrich life through technology

GUARANTEED SPECIFICATIONS

(Guaranteed specifications are measured according to EIA standard RS-490. AD denotes Analog Disc input.)

Performance Guaranty

All Accuphase product specifications are guaranteed as stated.

Frequency characteristics

- BALANCED INPUT: [CD/LINE]
 - 1.0 to 600,000Hz +0, -3.0dB
 - 20 to 20,000Hz +0, -0.2dB
- UNBALANCED INPUT: [CD/TUNER/LINE/TAPE PLAY]
 - 1.0 to 600,000Hz +0, -3.0dB
 - 20 to 20,000Hz +0, -0.2dB
- AD INPUT
 - 20 to 20,000Hz ±0.2dB

- Total harmonic distortion** 0.005% (for all input terminals)
- Input sensitivity and impedance**

Input terminal	Input sensitivity		Input impedance
	Rated output	0.5-V output	
AD: MM1	8.0mV	2.0mV	47kΩ
AD: MM2	4.0mV	1.0mV	47kΩ
AD: MC	0.25mV	0.063mV	100Ω
BALANCED	252mV	63mV	40kΩ
UNBALANCED	252mV	63mV	20kΩ

- Rated output and output impedance**
 - BALANCED OUTPUT: 2.0V, 50Ω, XLR type connector
 - UNBALANCED OUTPUT: 2.0V, 1Ω, RCA jack
 - TAPE REC: 252mV, 200Ω, RCA jack for AD input
- Headphone jack** Suitable impedance 4 to 600Ω
- S/N and input converted noise**

Input terminal	Input short-circuited (IHF-A compensated)		EIA S/N
	S/N with rated input	Input converted noise	
AD: MM1	96dB	-138dBV	90dB
AD: MM2	90dB	-138dBV	90dB
AD: MC	80dB	-152dBV	70dB
BALANCED	116dB	-128dBV	96dB
UNBALANCED	116dB	-128dBV	96dB

- Maximum output level (distortion ratio 0.005%, 20 to 20,000Hz)**
 - BALANCED OUTPUT: 7.0V, XLR type connector
 - UNBALANCED OUTPUT: 7.0V, RCA jack
 - TAPE REC: 7.0V, RCA jack for AC input
- AD maximum input voltage (distortion ratio 0.005%, 1kHz)**
 - MM1 INPUT: 250mV
 - MM2 INPUT: 125mV
 - MC INPUT: 8mV
- Minimum load impedance**
 - BALANCED OUTPUT: 600Ω
 - UNBALANCED OUTPUT: 1kΩ
 - TAPE REC: 10kΩ

- Gain**
 - BALANCED INPUT → BALANCED OUTPUT: 18dB
 - BALANCED INPUT → UNBALANCED OUTPUT: 18dB
 - BALANCED INPUT → REC OUTPUT: 0dB
 - UNBALANCED INPUT → BALANCED OUTPUT: 18dB
 - UNBALANCED INPUT → UNBALANCED OUTPUT: 18dB
 - UNBALANCED INPUT → REC OUTPUT: 0dB
 - AD [MM1/MM2] INPUT → BALANCED OUTPUT: 48/54dB
 - AD [MM1/MM2] INPUT → UNBALANCED OUTPUT: 48/54dB
 - AD [MM1/MM2] INPUT → REC OUTPUT: 30/36dB
 - AD [MC] INPUT → BALANCED OUTPUT: 78dB
 - AD [MC] INPUT → UNBALANCED OUTPUT: 78dB
 - AD [MC] INPUT → REC OUTPUT: 60dB
- Presence controller**
 - 4-band system
 - Frequency: 40Hz/100Hz switchable, 500Hz, 2kHz, 8kHz/20kHz switchable
 - Variable range: ±10dB

- Loudness compensator (when the audio volume set to -30dB)** +6dB (100Hz)
- Sub-sonic filter** 17Hz, -12dB/Oct.
- Attenuator** -20dB
- Semiconductors** 59 Tr., 25 FETs, 26 IC, 57 Di.
- Power supply and power consumption** 100V, 117V, 220V, 240V, 50/60Hz 19W
- Dimensions** 475mm (18-11/16") width, 149mm (5-7/8") height max., 375mm (14-3/4") depth
- Weight** 18.4kg (40.6 lbs.) net, 23.4kg (51.6 lbs.) in shipping carton

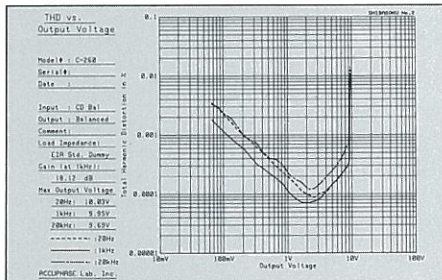

Output voltage vs. THD (Balanced CD input to balanced output)

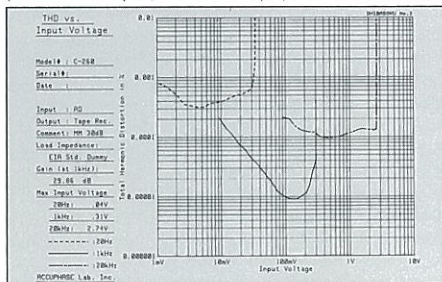

Input voltage vs. THD (MM input to tape output)

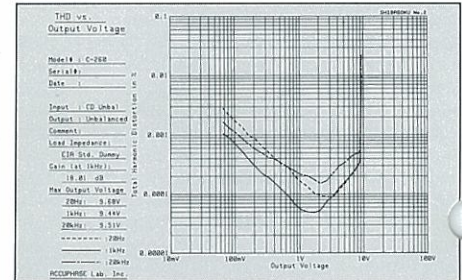

Output voltage vs. THD (Unbalanced CD input to unbalanced output)

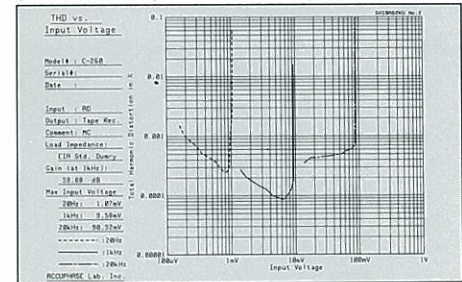

Input voltage vs. THD (MC input to tape output)



ACCUPHASE LABORATORY INC.